

ATS ALIMENTAZIONE CON CARRELLO SCORREVOLE

L'apparecchiatura A.T.S., prodotta dalla Teseo srl, permette di disporre facilmente lungo tutta la corsa del carrello, di fonti di energia fluida ed elettrica.

Questo sistema è composto da una rotaia componibile, da fissare mediante staffe alle pareti o alle strutture esistenti. Internamente allo speciale profilo della rotaia, si svolgono i tubi o i cavi che portano l'aria o la corrente fino al carrello.

Sulla rotaia scorre libero un carrello, sul quale vi sono le varie uscite per utilizzi.

I vantaggi di questo sistema sono:

- disporre in qualsiasi punto lungo la corsa del carrello di uscite di aria o di prese elettriche;
- poter sostenere il peso degli utensili portatili;
- ridurre il rischio di infortuni causato da tubi volanti o appoggiati a terra.

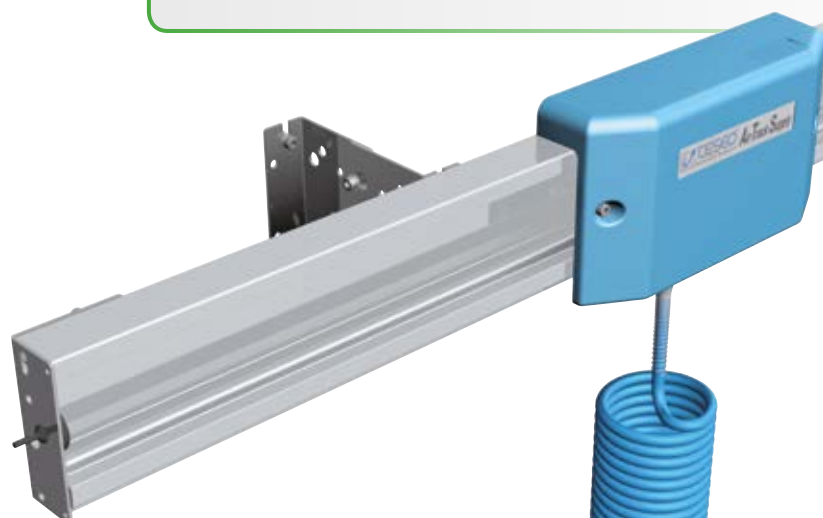

Caratteristiche Tecniche





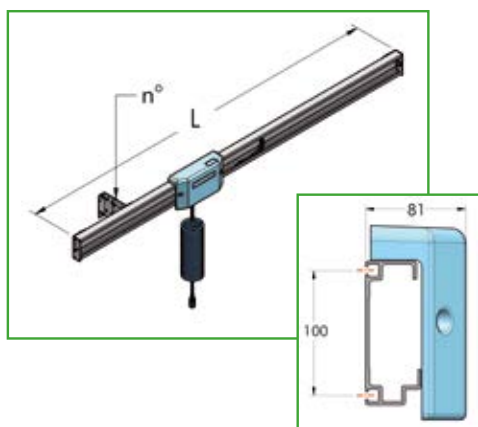

- Rotaia in alluminio estruso anodizzato.
- Carrello scorrevole su rotelle a sfere.
- Tubo di alimentazione \varnothing interno 8 mm.
- Pressione di esercizio: 8 bar.
- Tensione di alimentazione 220 V monofase.
- Peso approssimativo applicabile: 30 Kg.
- Cavo: 3G-2,5 mm² C/47

Gli impianti sono forniti in kit di montaggio rapido, racchiusi in una robusta confezione di cartone lunga 3 m, contenente tutti i gruppi che lo compongono già premontati, completi di staffe di fissaggio e istruzioni di montaggio. Sul carrello vi sono una uscita di aria compressa da 1/4" ed un moschettone di aggancio. Non sono compresi e vanno ordinati a parte:

- Accessori: vedere pagina 65;
- Utensili per il montaggio;
- Installazione presso il cliente.









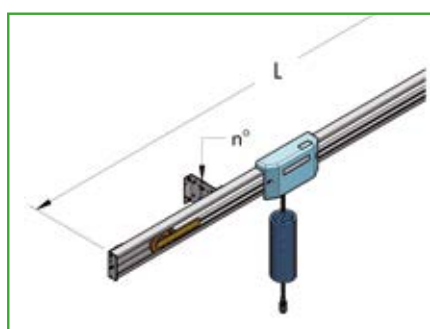







ATS PNEUMATICO, CON CATENA



L m	Codice N°	Staffe n°	P Kg	 n°	
1,5	001 003 001	2	10	1	
2	001 003 002	2	11	1	
2,5	001 003 081	2	12	1	
3	001 003 003	2	13	1	
4	001 003 004	4	15	1	

ATS PNEUMATICO, CON ASTA



L m	Codice N°	Staffe n°	P Kg	 n°	
5	001 003 005	4	20	1	
6	001 003 006	4	23	1	
7	001 003 007	4	25	1	
8	001 003 008	4	27	1	
9	001 003 009	6	30	1	
10	001 003 010	6	33	1	
11	001 003 011	6	35	1	
12	001 003 012	6	37	1	
13	001 003 013	8	40	1	
14	001 003 014	8	42	1	
15	001 003 015	8	44	1	
16	001 003 016	8	47	1	
17	001 003 017	10	49	1	
18	001 003 018	10	51	1	

ATS CON ALIMENTAZIONE ELETTRICA

Questi impianti, oltre all'alimentazione di aria compressa, hanno una alimentazione di corrente elettrica monofase con una uscita sul carrello con morsetteria tripolare ed una entrata ad un lato della rotaia con cassetta di sicurezza.

Le altre caratteristiche sono le stesse del modello standard.

ATS ELETTRIFICATO, CON CATENA

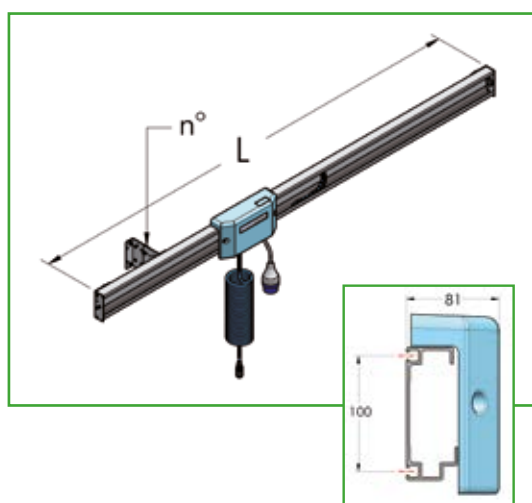

L m	Codice N°	Staffe n°	P Kg	n°	
1,5	001 004 001	2	13	1	
2	001 004 002	2	14	1	
2,5	001 004 081	2	15	1	
3	001 004 003	2	16	1	
4	001 004 004	4	18	1	

ATS ELETTRIFICATO, CON ASTA

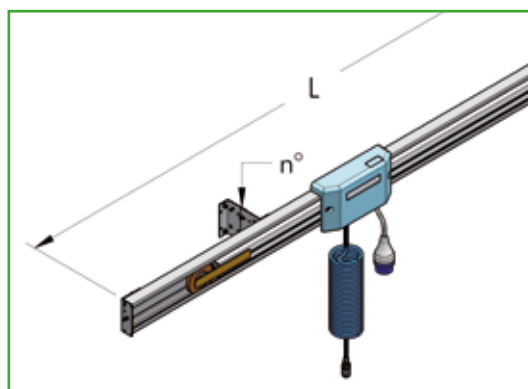





L m	Codice N°	Staffe n°	P Kg	n°	
5	001 004 005	4	24	1	
6	001 004 006	4	28	1	
7	001 004 007	4	31	1	
8	001 004 008	4	34	1	
9	001 004 009	6	36	1	
10	001 004 010	6	41	1	
11	001 004 011	6	44	1	
12	001 004 012	6	46	1	

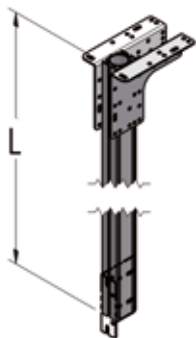

SUPPORTO DA PARETE O DA SOFFITTO

MAT





L m	Codice N°	P Kg	n°	
0,5	001 003 060	1,6	10	
1	001 003 061	2,5	10	
2	001 003 062	3,8	10	

BLOCCHETTO DI USCITA SUPPLEMENTARE, COMPLETO

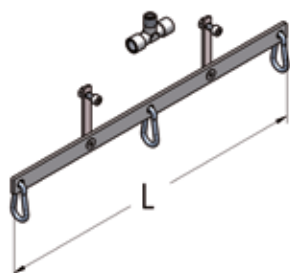
G	Codice N°	P g	n°	
1/4" - BSP	001 003 068	150	10	



SUPPORTO PORTAUTENSILI MULTIPLO CON 3 AGGANCI

L mm	Codice N°	P g	n°	
400	001 003 069	290	1	

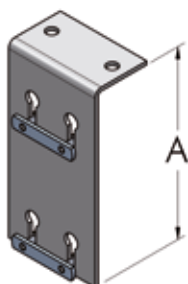

STAFFA DI FISSAGGIO SPECIALE

MAT

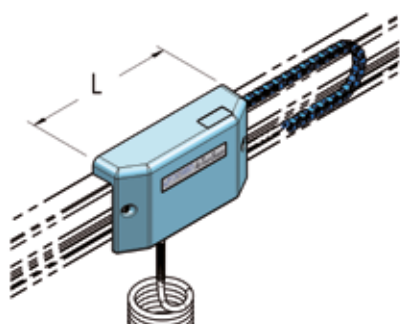

A mm	Codice N°	P g	n°	
160	001 005 036	400	20	

CARRELLO AGGIUNTIVO*

L mm	Codice N°	P Kg	n°	
270	001 003 067	1,7	1	

* Applicabile solo su A.T.S. pneumatico di 2, 3, 4 m

CATENA PORTACAVI



L m	Codice N°	P g	n°	
1	336 011 100	70	1	

TUBO TELATO



L m	Codice N°	P g	n°	
1	421 008 100	40	1	

GRUPPO TUBO CATENA



L* m	Codice N°	P g	n°	
1,5-4	001 002 040	-	1	

*Specificare la lunghezza ATS







GRUPPO TUBO CORDINO









L* m	Codice N°	P g	n°	
5-18	001 002 024	-	1	

*Specificare la lunghezza ATS



ROTAIA

L m	Codice N°	P Kg	 n°	
1	801 115 100	1,8	1	
1,5	801 115 150	2,6	1	
2	801 115 200	3,5	1	
2,5	801 115 250	4,4	1	
3	801 115 300	5,3	1	

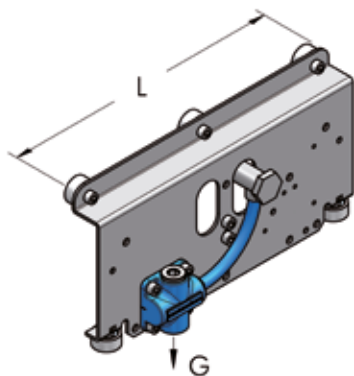

ROTAIA FORATA

L m	Codice N°	P Kg	 n°	
1,5	802 115 150	2,6	1	
2	802 115 200	3,7	1	
2,5	802 115 250	4,4	1	
3	802 115 300	5,3	1	

GRUPPO CARRELLO

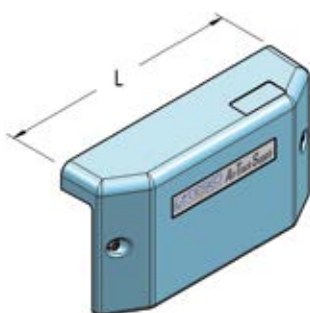
L mm	G	Codice N°	P g	 n°	
270	1/4" - BSP	001 003 020	1450	1	

GRUPPO CARTER

L mm	Codice N°	P g	 n°	
270	001 003 022	185	1	

GRUPPO GIUNTO INTERMEDIO

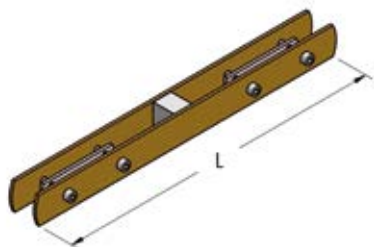

L mm	Codice N°	P g	n°	
220	001 002 028	540	1	

GRUPPO CARRUCOLE

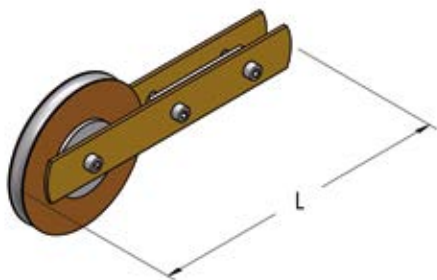

L mm	Codice N°	P g	n°	
250	001 002 026	1600	2	

GRUPPO TERMINALI

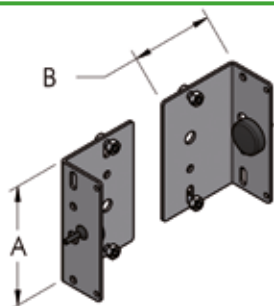

A mm	B mm	Codice N°	P g	n°	
115	80	001 002 034	555	1	

GRUPPO STAFFAGGI STANDARD

MAT



L mm	Codice N°	P g	n°	
125-135	001 003 036	550	1	

GRUPPO PIASTRE DI GIUNZIONE (2)

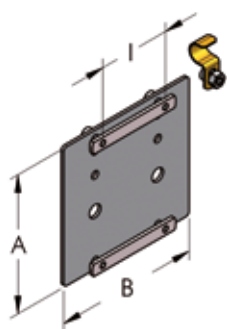

B mm	A mm	I mm	Codice N°	P g	n°	
120	115	60	001 003 030	650	1	



ATS

